

General Description

The MIC4680 SuperSwitcher™ is an easy-to-use fixed or adjustable output voltage step-down (buck) switch-mode voltage regulator. The 200kHz MIC4680 achieves up to 1.3A of continuous output current over a wide input range in a 8-lead SOP (small outline package).

The MIC4680 is available in 3.3V and 5V fixed output versions or adjustable output down to 1.25V.

The MIC4680 has an input voltage range of 4V to 34V, with excellent line, load, and transient response. The regulator performs cycle-by-cycle current limiting and thermal shutdown for protection under fault conditions. In shutdown mode, the regulator draws less than 2µA of standby current.

The MIC4680 SuperSwitcher™ regulator requires a minimum number of external components and can operate using a standard series of inductors and capacitors. Frequency compensation is provided internally for fast transient response and ease of use.

The MIC4680 is available in the 8-lead SOP with a -40°C to +125°C junction temperature range.

Features

- SO-8 package with up to 1.3A output current
- All surface mount solution
- Only 4 external components required
- Fixed 200kHz operation
- 3.3V, 5V, and adjustable output versions
- Internally compensated with fast transient response
- Wide 4V to 34V operating input voltage range
- Less than 2µA typical shutdown-mode current
- Up to 90% efficiency
- Thermal shutdown
- Overcurrent protection

Applications

- Simple 1A high-efficiency step-down (buck) regulator
- Replacement of TO-220 and TO-263 designs
- Efficient preregulator (5V to 2.5V, 12V to 3.3V, etc.)
- On-card switching regulators
- Positive-to-negative converter (inverting buck-boost)
- Simple battery charger
- Negative boost converter
- Higher output current regulator using external FET

Typical Applications

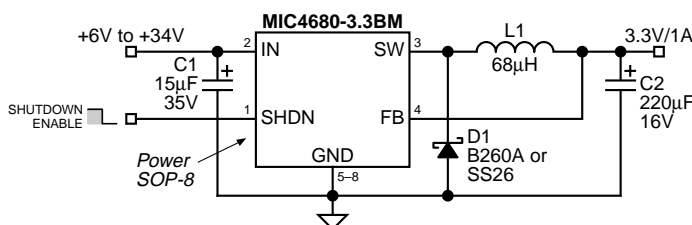

Fixed Regulator Circuit

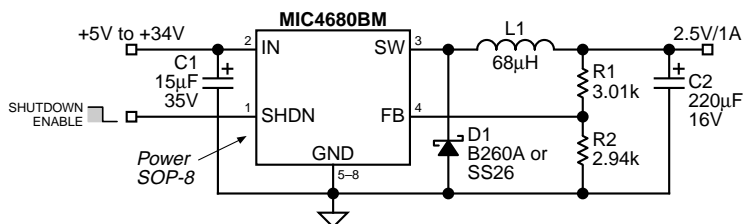

Adjustable Regulator Circuit

SuperSwitcher is a trademark of Micrel, Inc.

Micrel, Inc. • 1849 Fortune Drive • San Jose, CA 95131 • USA • tel + 1 (408) 944-0800 • fax + 1 (408) 944-0970 • <http://www.micrel.com>

Ordering Information

Part Number	Voltage	Junction Temp. Range	Package
MIC4680BM	Adjustable	-40°C to +125°C	8-lead SOP
MIC4680-3.3BM	3.3V	-40°C to +125°C	8-lead SOP
MIC4680-5.0BM	5.0V	-40°C to +125°C	8-lead SOP

Pin Configuration

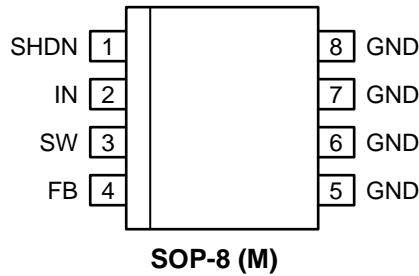

Pin Description

Pin Number	Pin Name	Pin Function
1	SHDN	Shutdown (Input): Logic low enables regulator. Logic high (>1.6V) shuts down regulator.
2	VIN	Supply Voltage (Input): Unregulated +4V to +34V supply voltage.
3	SW	Switch (Output): Emitter of NPN output switch. Connect to external storage inductor and Shottky diode.
4	FB	Feedback (Input): Connect to output on fixed output voltage versions, or to 1.23V-tap of voltage-divider network for adjustable version.
5-8	GND	Ground

Absolute Maximum Ratings (Note 1)

Supply Voltage (V_{IN}), Note 3	+38V
Shutdown Voltage (V_{SHDN})	-0.3V to +38V
Steady-State Output Switch Voltage (V_{SW})	-1V
Feedback Voltage [Adjustable] (V_{FB})	+12V
Storage Temperature (T_S)	-65°C to +150°C

ESD, Note 5

Operating Ratings (Note 2)

Supply Voltage (V_{IN}), Note 4	+4V to +34V
Junction Temperature (T_J)	+125°C
Package Thermal Resistance (θ_{JA}), Note 6	63°C/W

Electrical Characteristics

$V_{IN} = 12V$; $I_{LOAD} = 500mA$; $T_J = 25^\circ C$, **bold** values indicate $-40^\circ C \leq T_J \leq +125^\circ C$, **Note 7**; unless noted.

Parameter	Condition	Min	Typ	Max	Units
MIC4680 [Adjustable]					
Feedback Voltage	(±1%)	1.217	1.230	1.243	V
	(±2%)	1.205		1.255	V
	$8V \leq V_{IN} \leq 34V$, $0.1A \leq I_{LOAD} \leq 1A$, $V_{OUT} = 5V$	1.193 1.180	1.230	1.267 1.280	V V
Maximum Duty Cycle	$V_{FB} = 1.0V$	93	97		%
Output Leakage Current	$V_{IN} = 34V$, $V_{SHDN} = 5V$, $V_{SW} = 0V$		50	500	μA
	$V_{IN} = 34V$, $V_{SHDN} = 5V$, $V_{SW} = -1V$		4	20	mA
Quiescent Current	$V_{FB} = 1.5V$		7	12	mA
MIC4680-3.3					
Output Voltage	(±1%)	3.266	3.3	3.333	V
	(±3%)	3.201		3.399	V
	$6V \leq V_{IN} \leq 34V$, $0.1A \leq I_{LOAD} \leq 1A$	3.168 3.135	3.3	3.432 3.465	V V
Maximum Duty Cycle	$V_{FB} = 2.5V$	93	97		%
Output Leakage Current	$V_{IN} = 34V$, $V_{SHDN} = 5V$, $V_{SW} = 0V$		50	500	μA
	$V_{IN} = 34V$, $V_{SHDN} = 5V$, $V_{SW} = -1V$		4	20	mA
Quiescent Current	$V_{FB} = 4.0V$		7	12	mA
MIC4680-5.0					
Output Voltage	(±1%)	4.950	5.0	5.05	V
	(±3%)	4.85		5.15	V
	$8V \leq V_{IN} \leq 34V$, $0.1A \leq I_{LOAD} \leq 1A$	4.800 4.750	5.0	5.200 5.250	V V
Maximum Duty Cycle	$V_{FB} = 4.0V$	93	97		%
Output Leakage Current	$V_{IN} = 34V$, $V_{SHDN} = 5V$, $V_{SW} = 0V$		50	500	μA
	$V_{IN} = 34V$, $V_{SHDN} = 5V$, $V_{SW} = -1V$		4	20	mA
Quiescent Current	$V_{FB} = 6.0V$		7	12	mA

Parameter	Condition	Min	Typ	Max	Units
MIC4680/-3.3/-5.0					
Frequency Fold Back		30	50	100	kHz
Oscillator Frequency		180	200	220	kHz
Saturation Voltage	$I_{OUT} = 1A$		1.4	1.8	V V
Short Circuit Current Limit	$V_{FB} = 0V$, see Test Circuit	1.3	1.8	2.5	A
Standby Quiescent Current	$V_{SHDN} = V_{IN}$		1.5		μA
	$V_{SHDN} = 5V$ (regulator off)		30	100	μA
Shutdown Input Logic Level	regulator off	2	1.6		V
	regulator on		1.0	0.8	V
Shutdown Input Current	$V_{SHDN} = 5V$ (regulator off)	-10	-0.5	10	μA
	$V_{SHDN} = 0V$ (regulator on)	-10	-1.5	10	μA
Thermal Shutdown			160		$^{\circ}C$

- Note 1.** Exceeding the absolute maximum rating may damage the device.
- Note 2.** The device is not guaranteed to function outside its operating rating.
- Note 3.** Absolute maximum rating is intended for voltage transients only, prolonged dc operation is not recommended.
- Note 4.** $V_{IN(min)} = V_{OUT} + 2.5V$ or $4V$ whichever is greater.
- Note 5.** Devices are ESD sensitive. Handling precautions recommended.
- Note 6.** Measured on 1" square of 1 oz. copper FR4 printed circuit board connected to the device ground leads.
- Note 7.** Test at $T_A = +85^{\circ}C$, guaranteed by design, and characterized to $T_J = +125^{\circ}C$.

Test Circuit

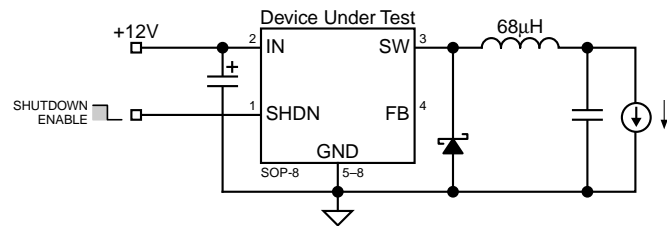

Current Limit Test Circuit

Shutdown Input Behavior

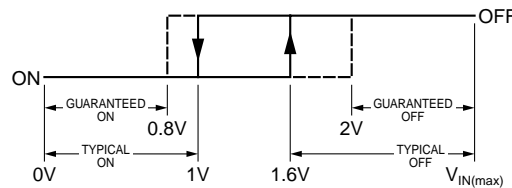

Shutdown Hysteresis

Typical Characteristics

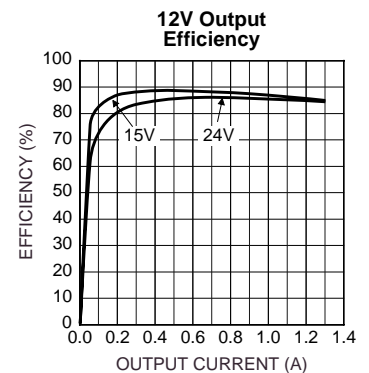
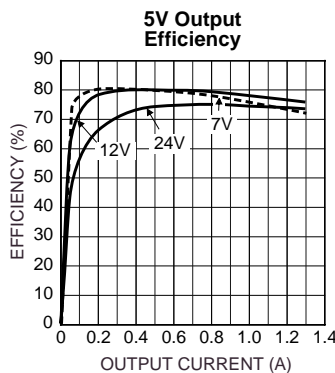
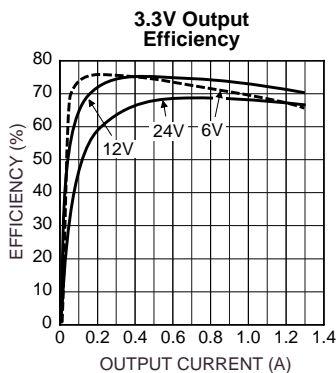
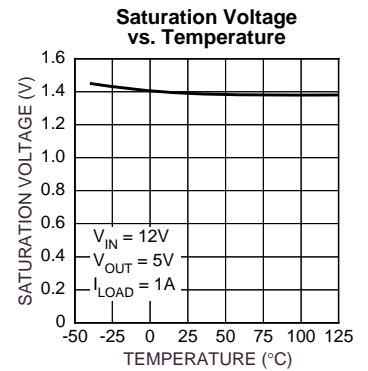
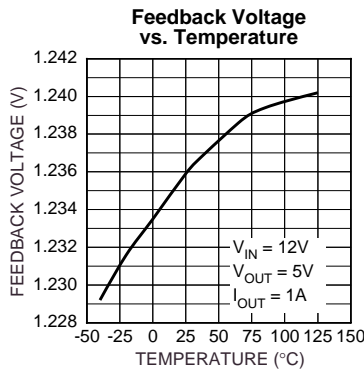
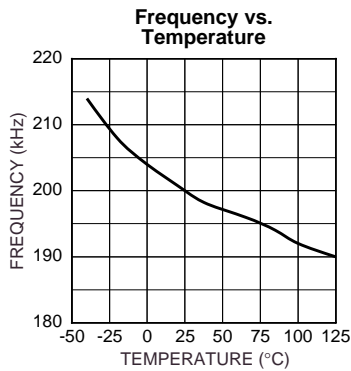
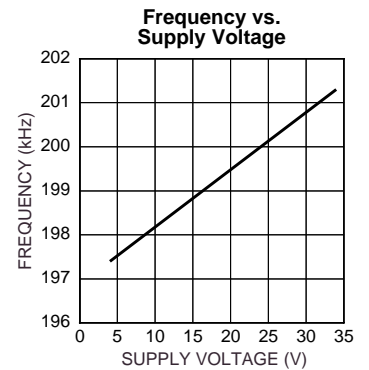
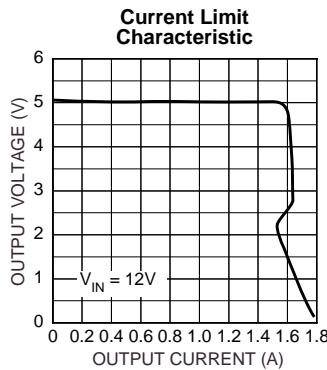
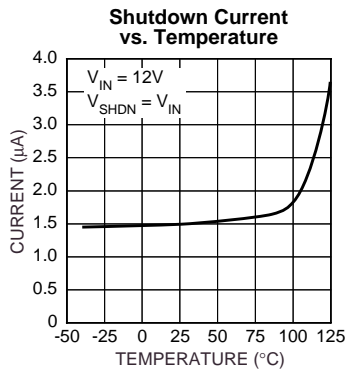
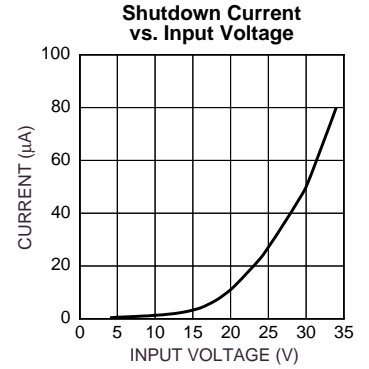
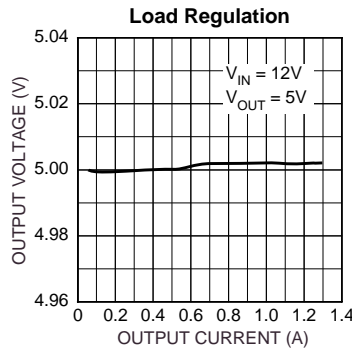
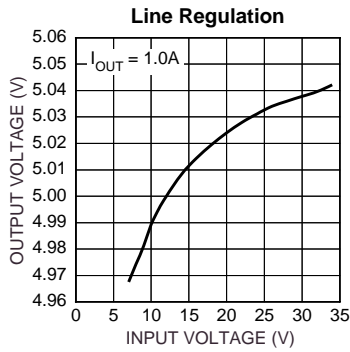

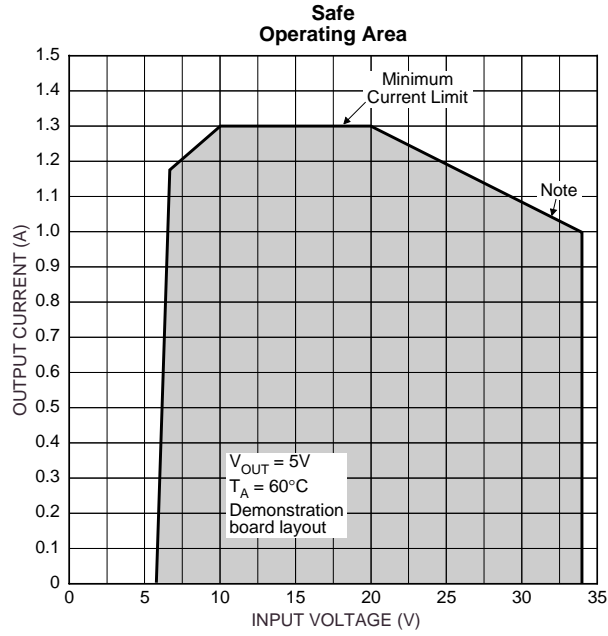

Note. For increased output current, see “Applications Information: Increasing the Maximum Output Current” and Figure 3.

Functional Characteristics

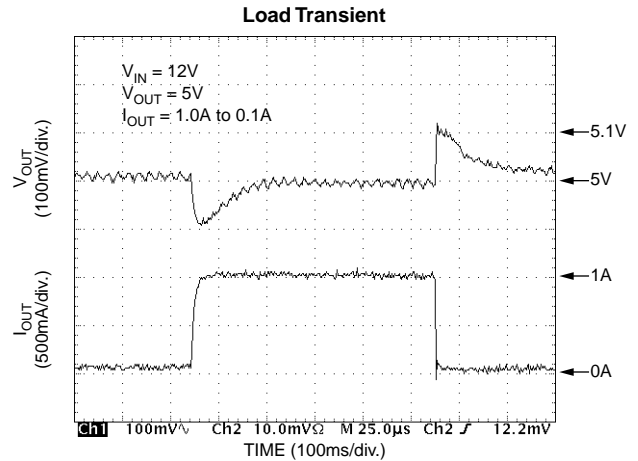
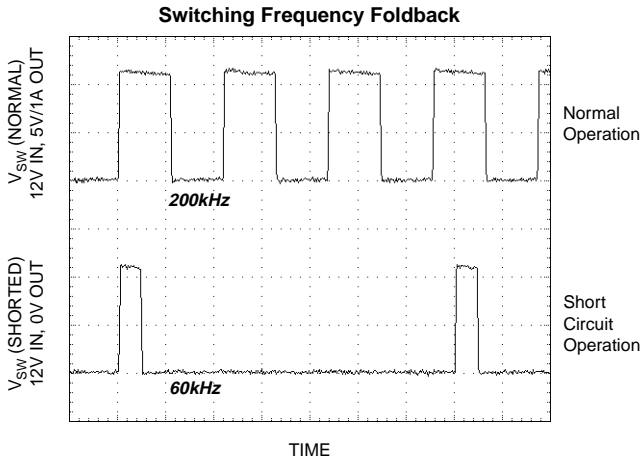

Frequency Foldback

The MIC4680 folds the switching frequency back during a hard short-circuit condition to reduce the energy per cycle and protect the device.

Bode Plots

The following bode plots show that the MIC4680 is stable over all conditions using a **68 μ F inductor (L)** and a **220 μ F output capacitor (C_{OUT})**. To assure stability, it is a good practice to maintain a phase margin of greater than 35°.

No-Load Stability
Phase Margin = 106°

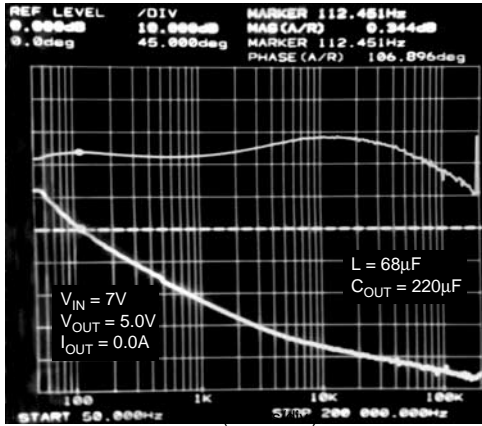

Full-Load Stability
Phase Margin = 114°

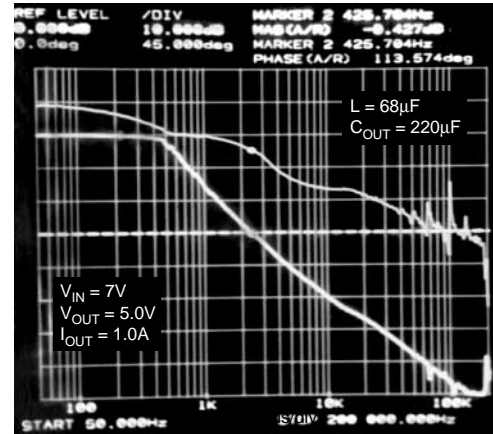

No-Load Stability
Phase Margin = 117°

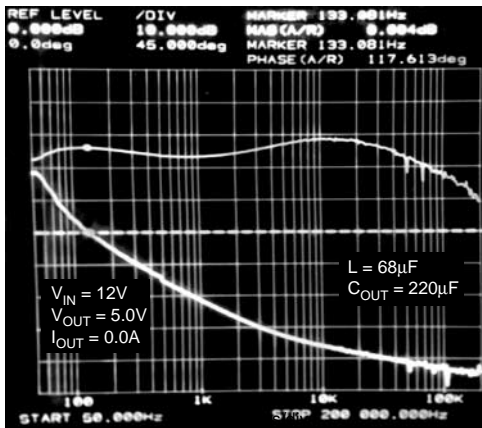

Full-Load Stability
Phase Margin = 69°

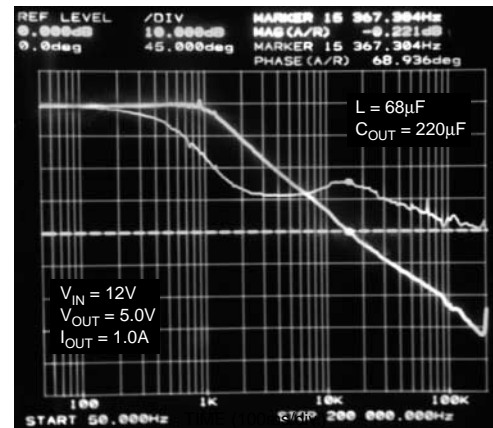

No-Load Stability
Phase Margin = 125°

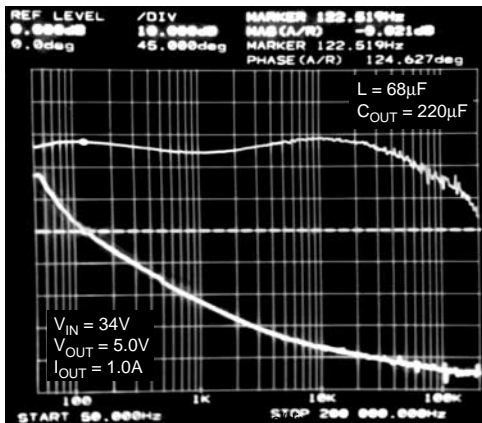

Full-Load Stability
Phase Margin = 71°

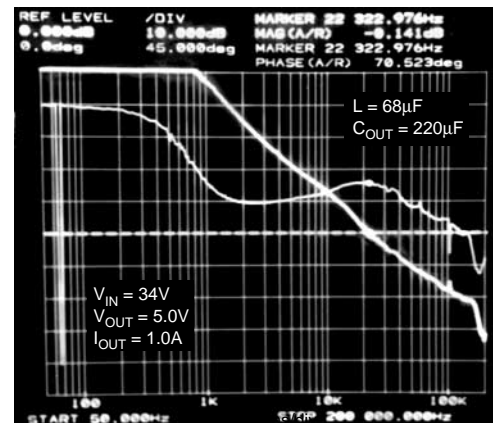

Block Diagrams

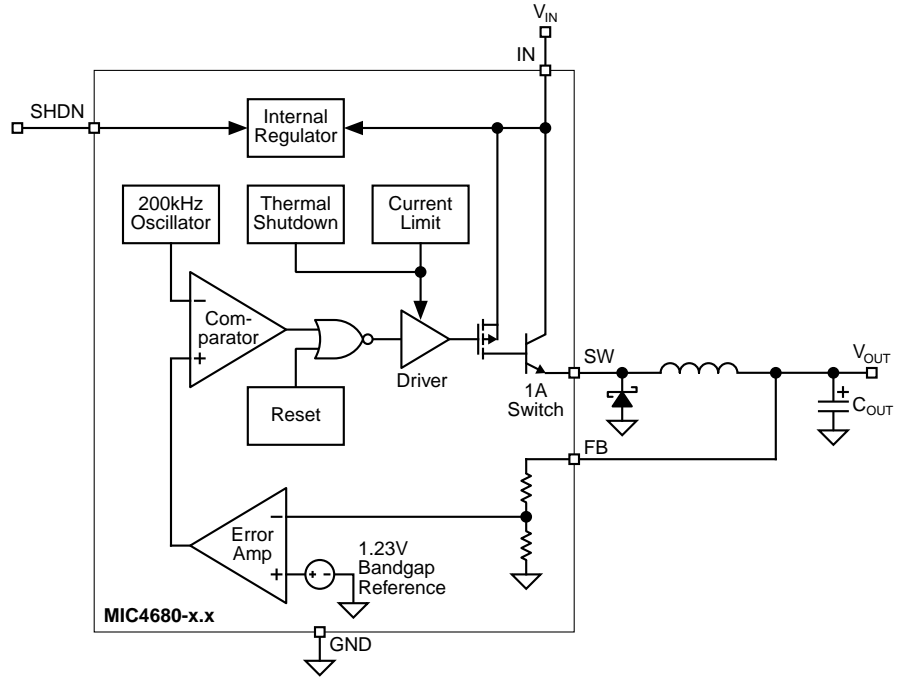

Fixed Regulator

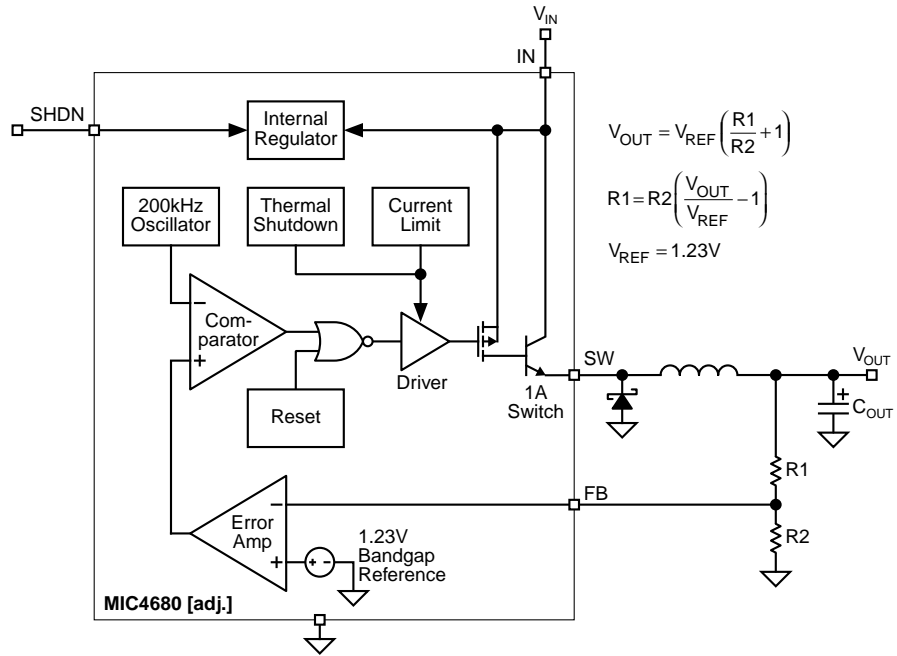

$$V_{OUT} = V_{REF} \left(\frac{R1}{R2} + 1 \right)$$

$$R1 = R2 \left(\frac{V_{OUT}}{V_{REF}} - 1 \right)$$

$$V_{REF} = 1.23V$$

Adjustable Regulator

Functional Description

The MIC4680 is a variable duty cycle switch-mode regulator with an internal power switch. Refer to the block diagrams.

Supply Voltage

The MIC4680 operates from a +4V to +34V unregulated input. Highest efficiency operation is from a supply voltage around +15V. See the efficiency curves.

Enable/Shutdown

The shutdown (SHDN) input is TTL compatible. Ground the input if unused. A logic-low enables the regulator. A logic-high shuts down the internal regulator which reduces the current to typically 1.5 μ A when $V_{SHDN} = V_{IN} = 12V$ and 30 μ A when $V_{SHDN} = 5V$. See "Shutdown Input Behavior: Shutdown Hysteresis."

Feedback

Fixed-voltage versions of the regulator have an internal resistive divider from the feedback (FB) pin. Connect FB directly to the output voltage.

Adjustable versions require an external resistive voltage divider from the output voltage to ground, center tapped to the FB pin. See Figure 6b for recommended resistor values.

Duty Cycle Control

A fixed-gain error amplifier compares the feedback signal with a 1.23V bandgap voltage reference. The resulting error amplifier output voltage is compared to a 200kHz sawtooth waveform to produce a voltage controlled variable duty cycle output.

A higher feedback voltage increases the error amplifier output voltage. A higher error amplifier voltage (comparator inverting input) causes the comparator to detect only the peaks of the sawtooth, reducing the duty cycle of the comparator output. A lower feedback voltage increases the duty cycle. The MIC4680 uses a voltage-mode control architecture.

Output Switching

When the internal switch is on, an increasing current flows from the supply V_{IN} , through external storage inductor L1, to output capacitor C_{OUT} and the load. Energy is stored in the inductor as the current increases with time.

When the internal switch is turned off, the collapse of the magnetic field in L1 forces current to flow through fast recovery diode D1, charging C_{OUT} .

Output Capacitor

External output capacitor C_{OUT} provides stabilization and reduces ripple. See "Bode Plots" for additional information.

Return Paths

During the on portion of the cycle, the output capacitor and load currents return to the supply ground. During the off portion of the cycle, current is being supplied to the output capacitor and load by storage inductor L1, which means that D1 is part of the high-current return path.

Applications Information

Adjustable Regulators

Adjustable regulators require a 1.23V feedback signal. Recommended voltage-divider resistor values for common output voltages are included in Figure 1b.

For other voltages, the resistor values can be determined using the following formulas:

$$V_{OUT} = V_{REF} \left(\frac{R1}{R2} + 1 \right)$$

$$R1 = R2 \left(\frac{V_{OUT}}{V_{REF}} - 1 \right)$$

$$V_{REF} = 1.23V$$

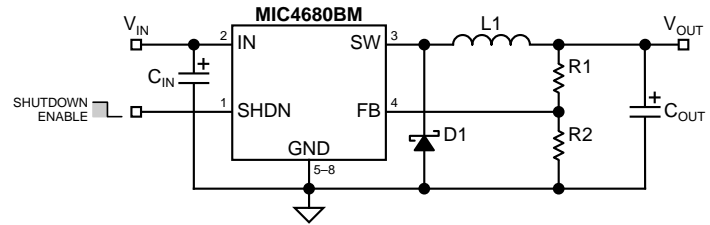

Figure 1a. Adjustable Regulator Circuit

V _{OUT}	R1*	R2*	C _{IN}	D1	L1	C _{OUT}
1.8V	3.01k	6.49k	15μF 35V AVX TPSE156035R0200	2A 60V Schottky B260A Vishay-Diode, Inc.*** or SS26 General Semiconductor	68μH 1.5A Coiltronics UP2B-680 or Sumida CDRH125-680MC** or Sumida CDRH124-680MC**	220μF 10V AVX TPSE227010R0060
2.5V	3.01k	2.94k				
3.3V	3.01k	1.78k				
5.0V	3.01k	976Ω				
6.0V	3.01k	787Ω				

* All resistors 1%

** shielded magnetics for low RFI applications

*** Vishay-Diode, Inc. (805) 446-4800

Figure 1b. Recommended Components for Common Output Voltages

Thermal Considerations

The MIC4680 SuperSwitcher features the power-SOP-8. This package has a standard 8-lead small-outline package profile but with much higher power dissipation than a standard SOP-8. The MIC4680 SuperSwitcher is the first dc-to-dc converter to take full advantage of this package.

The reason that the power SOP-8 has higher power dissipation (lower thermal resistance) is that pins 5 through 8 and the die-attach paddle are a single piece of metal. The die is attached to the paddle with thermally conductive adhesive. This provides a low thermal resistance path from the junction of the die to the ground pins. This design significantly improves package power dissipation by allowing excellent heat transfer through the ground leads to the printed circuit board.

One of the limitation of the maximum output current on any MIC4680 design is the junction-to-ambient thermal resistance (θ_{JA}) of the design (package and ground plane).

Examining θ_{JA} in more detail:

$$\theta_{JA} = (\theta_{JC} + \theta_{CA})$$

where:

θ_{JC} = junction-to-case thermal resistance

θ_{CA} = case-to-ambient thermal resistance

θ_{JC} is a relatively constant 20°C/W for a power SOP-8.

θ_{CA} is dependent on layout and is primarily governed by the connection of pins 5 through 8 to the ground plane. The purpose of the ground plane is to function as a heat sink.

θ_{JA} is ideally 63°C/W but will vary depending on the size of the ground plane to which the power SOP-8 is attached.

Determining Ground-Plane Heat-Sink Area

There are two methods of determining the minimum ground plane area required by the MIC4680.

Quick Method

Make sure that MIC4680 pins 5 through 8 are connected to a ground plane with a minimum area of 6cm². This ground plane should be as close to the MIC4680 as possible. The area maybe distributed in any shape around the package or on any pcb layer *as long as there is good thermal contact to pins 5 through 8*. This ground plane area is more than sufficient for most designs.

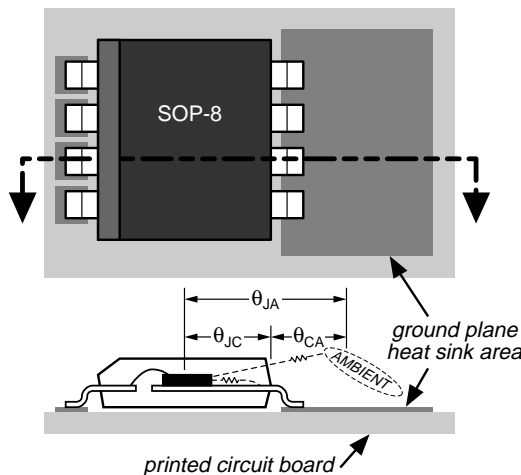

Figure 2. Power SOP-8 Cross Section

Minimum Copper/Maximum Current Method

Using Figure 3, for a given input voltage range, determine the minimum ground-plane heat-sink area required for the application's maximum output current. Figure 3 assumes a constant die temperature of 75°C above ambient.

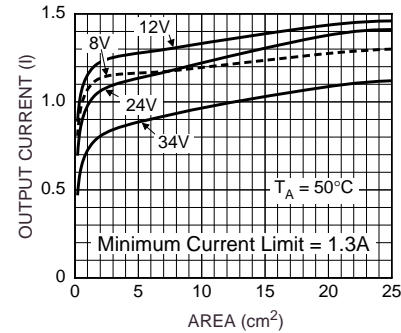

Figure 3. Output Current vs. Ground Plane Area

When designing with the MIC4680, it is a good practice to connect pins 5 through 8 to the largest ground plane that is practical for the specific design.

Checking the Maximum Junction Temperature:

For this example, with an output power (P_{OUT}) of 5W, (5V output at 1A maximum with $V_{IN} = 12V$) and 65°C maximum ambient temperature, what is the maximum junction temperature?

Referring to the “Typical Characteristics: 5V Output Efficiency” graph, read the efficiency (η) for 1A output current at $V_{IN} = 12V$ or perform you own measurement.

$$\eta = 79\%$$

The efficiency is used to determine how much of the output power (P_{OUT}) is dissipated in the regulator circuit (P_D).

$$P_D = \frac{P_{OUT}}{\eta} - P_{OUT}$$

$$P_D = \frac{5W}{0.79} - 5W$$

$$P_D = 1.33W$$

A worst-case rule of thumb is to assume that 80% of the total output power dissipation is in the MIC4680 ($P_{D(IC)}$) and 20% is in the diode-inductor-capacitor circuit.

$$P_{D(IC)} = 0.8 P_D$$

$$P_{D(IC)} = 0.8 \times 1.33W$$

$$P_{D(IC)} = 1.064W$$

Calculate the worst-case junction temperature:

$$T_J = P_{D(IC)} \theta_{JC} + (T_C - T_A) + T_{A(max)}$$

where:

T_J = MIC4680 junction temperature

$P_{D(IC)}$ = MIC4680 power dissipation

θ_{JC} = junction-to-case thermal resistance.

The θ_{JC} for the MIC4680's power-SOP-8 is approximately 20°C/W. (Also see Figure 1.)

T_C = “pin” temperature measurement taken at the entry point of pins 6 or 7 into the plastic package

at the ambient temperature (T_A) at which T_C is measured.

T_A = ambient temperature at which T_C is measured.

$T_{A(max)}$ = maximum ambient operating temperature for the specific design.

Calculating the maximum junction temperature given a maximum ambient temperature of 65°C:

$$T_J = 1.064 \times 20^\circ\text{C/W} + (45^\circ\text{C} - 25^\circ\text{C}) + 65^\circ\text{C}$$

$$T_J = 106.3^\circ\text{C}$$

This value is less than the allowable maximum operating junction temperature of 125°C as listed in “Operating Ratings.” Typical thermal shutdown is 160°C and is listed in “Electrical Characteristics.”

Increasing the Maximum Output Current

The maximum output current at high input voltages can be increased for a given board layout. The additional three

components shown in Figure 4 will reduce the overall loss in the MIC4680 by about 20% at high V_{IN} and high I_{OUT} .

Even higher output current can be achieved by using the MIC4680 to switch an external FET. See Figure 9 for a 5A supply with current limiting.

Layout Considerations

Layout is very important when designing any switching regulator. Rapidly changing switching currents through the printed circuit board traces and stray inductance can generate voltage transients which can cause problems.

To minimize stray inductance and ground loops, keep trace lengths, indicated by the heavy lines in Figure 5, as short as possible. For example, keep D1 close to pin 3 and pins 5 through 8, keep L1 away from sensitive node FB, and keep C_{IN} close to pin 2 and pins 5 through 8. See “Applications Information: Thermal Considerations” for ground plane layout.

The feedback pin should be kept as far way from the switching elements (usually L1 and D1) as possible.

A circuit with sample layouts are provided. See Figure 6a through 6e.

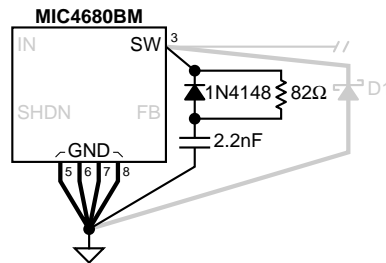

Figure 4. Increasing Maximum Output Current at High Input Voltages

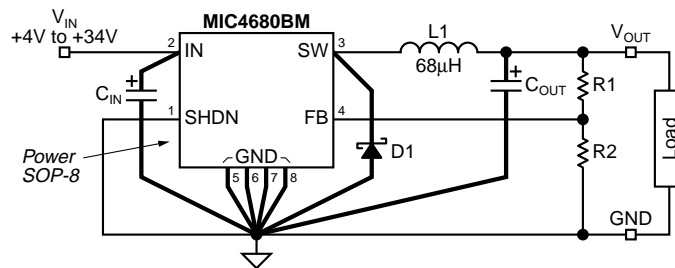
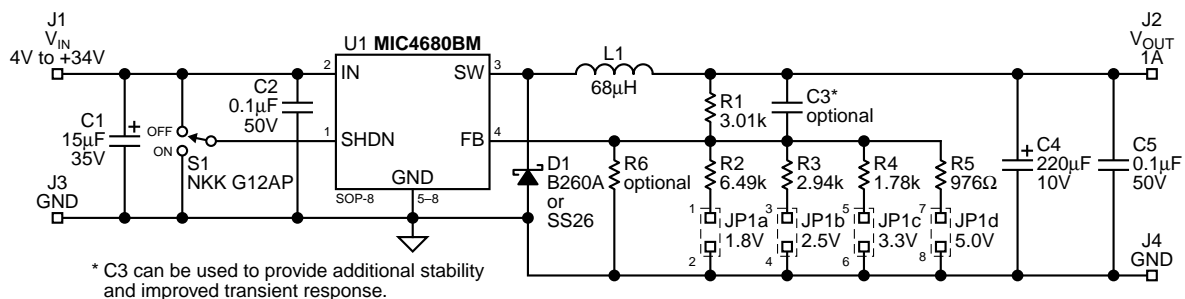

Figure 5. Critical Traces for Layout



* C3 can be used to provide additional stability and improved transient response.

Figure 6a. Evaluation Board Schematic Diagram

Printed Circuit Board Layouts

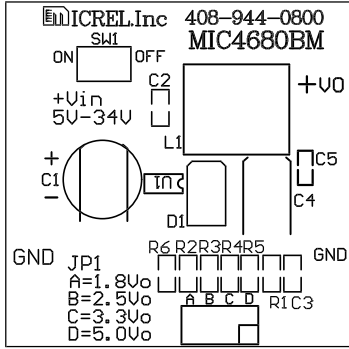

Figure 6b. Top-Side Silk Screen

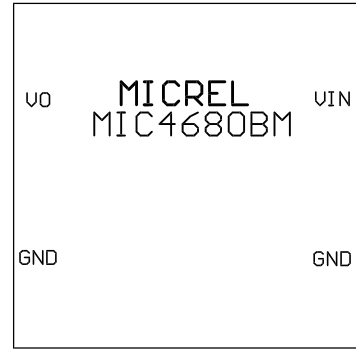

Figure 6d. Bottom-Side Silk Screen

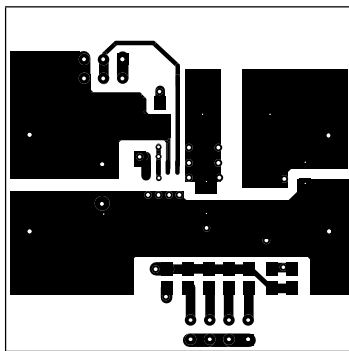

Figure 6c. Top-Side Copper

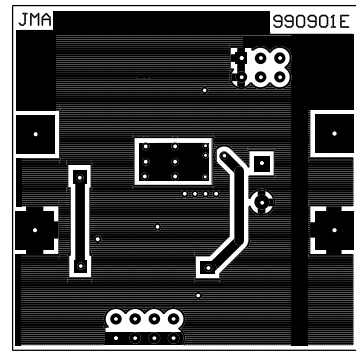

Figure 6e. Bottom-Side Copper

Abbreviated Bill of Material (Critical Components)

Reference	Part Number	Manufacturer	Description	Qty
C1	TPSD156M035R0300 ECE-A1HFS470	AVX ¹ Panasonic ²	15μF 35V 47μF 50V, 8mm × 11.5mm	1
C4	TPSD227M010R0150	AVX	220μF 10V	1
D1	B260A SS26	Vishay-Diodes, Inc. ³ General Semiconductor	Schottky	1
L1	UP2B-680 CDH115-680MC CDRH124-680MC	Coiltronics ⁴ Sumida ⁵ Sumida ⁵	68μH, 1.5A, nonshielded 68μH, 1.5A, nonshielded 68μH, 1.5A, shielded	1
U1	MIC4680BM	Micrel Semiconductor ⁶	1A 200kHz power-SO-8 buck regulator	1

¹ AVX: <http://www.avxcorp.com>

² Panasonic: <http://www.maco.panasonic.co.jp/eccd/index.html>

³ Vishay-Diodes, Inc., tel: (805) 446-4800, <http://www.diodes.com>

⁴ Coiltronics, tel: (561) 241-7876, <http://www.coiltronics.com>

⁵ Sumida, tel: (408) 982-9960, <http://www.sumida.com>

⁶ Micrel, tel: (408) 944-0800, <http://www.micrel.com>

Applications Circuits*

For continuously updated circuits using the MIC4680, see *Application Hint 37* at www.micrel.com.

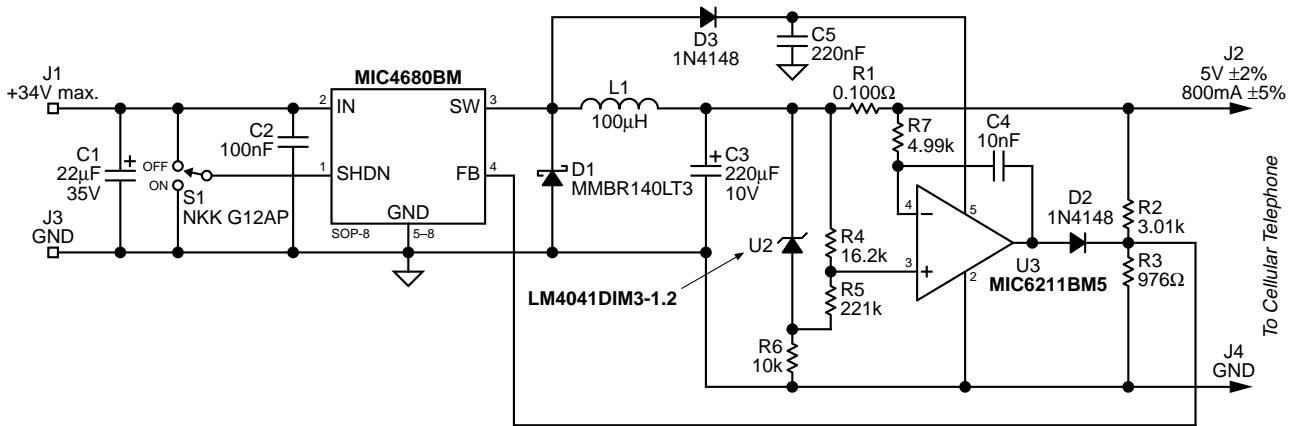

Figure 7. Constant Current and Constant Voltage Battery Charger

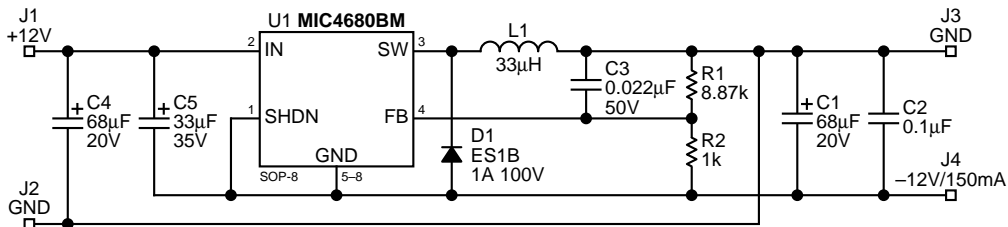

Figure 8. +12V to -12V/150mA Buck-Boost Converter

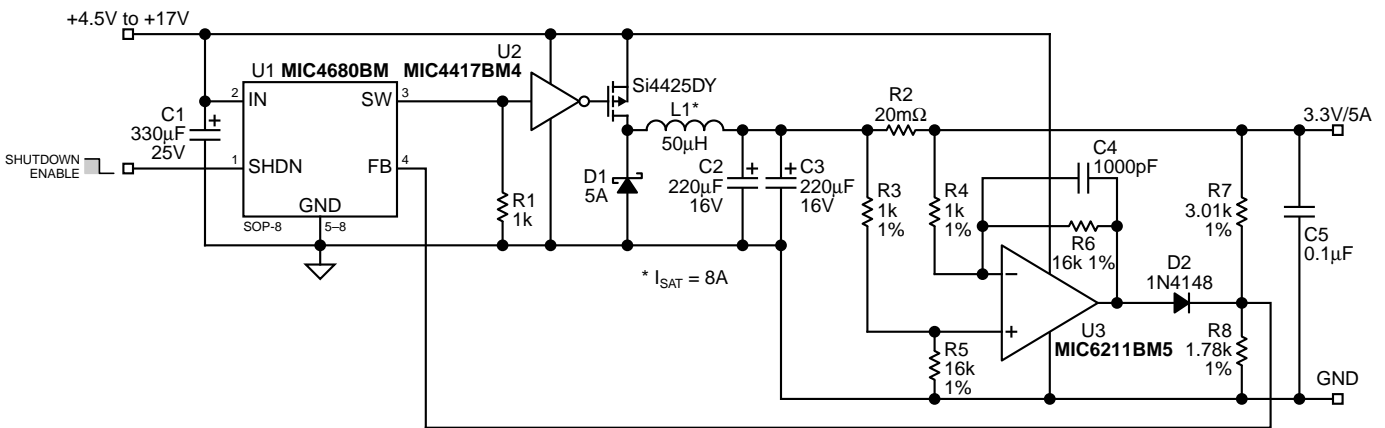
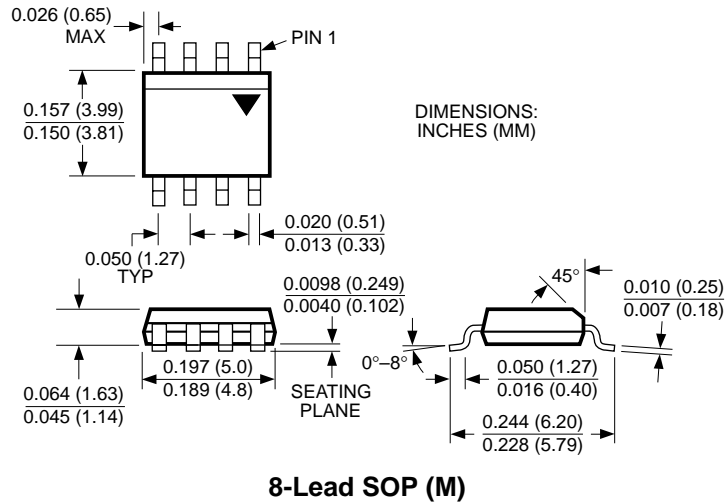

Figure 9. 5V to 3.3V/5A Power Supply

* See Application Hint 37 for bills of material.

Package Information



MICREL INC. 1849 FORTUNE DRIVE SAN JOSE, CA 95131 USA

TEL + 1 (408) 944-0800 FAX + 1 (408) 944-0970 WEB <http://www.micrel.com>

This information is believed to be accurate and reliable, however no responsibility is assumed by Micrel for its use nor for any infringement of patents or other rights of third parties resulting from its use. No license is granted by implication or otherwise under any patent or patent right of Micrel Inc.

© 2000 Micrel Incorporated